

Installation Guide of CP-GM3 Ground And flat roof solar Mounting system

Benefits

1. Fast installation.

The support is pre-assembled, just open it and fix the solar panel, five steps to finish the installations in addition. The tilt-in module can be put into the rail from the any location and can be high pre-assembled with the clamp. All these minimizes the time and cost of installation.

2. Offer unmatched durability.

with all structural components comprised of high class stainless steel and anodized aluminum alloy, it is designed for 25 years service life and backed by ten years warranty.

3. Stand up to extreme weather.

This solar racking system is designed to stand up to the extreme weather complied with the AS/NZS 1170 and other international structure load standard by the skilled engineer. The main support components also have been tested to guaranty its structure and load-carrying capacity.

4. Provide broad installation flexibility.

This solar racking system accommodate most of commercially available solar panels and diverse roof types, and they can scale easily from small to large, multi-megawatt installations.



Matters needing attention

The structural stability of the PV-system must be verified before installation. The building must be able to support the additional weight safely.

Installation notes

please read these installation instructions carefull before starting the installaction and familiarise yourself with the system components. during the installation and in particular whilst working on the roof, ensure to work according to the relevant health and safect guidelines, safety guidelines and please follow the current rules and regulations for your corres ponding region. The individual installation insturctions are merely recommendations in accordance with

the current state of technology and are based on previous experiences of how corigy systems can be installed
Installation guidelines

Installation guidelines

(1) Install technicians to provide technical disclosure.

(2) Distribute the components to each construction site according to the installation sequence of the unit area and prepare for installation.

(3) The appearance and protective layer of the stent should be intact, remove the mud sand, dust and stains on the stent components, and keep the stent components dry and tidy.

(4) Check whether the bracket components have obvious bending deformation, and prohibit the use of components that do not meet the installation requirements.

Components List

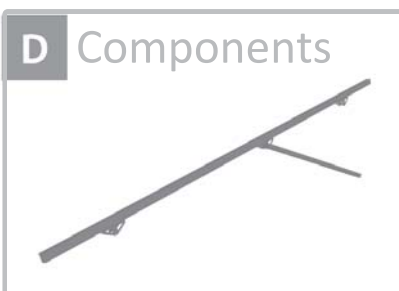
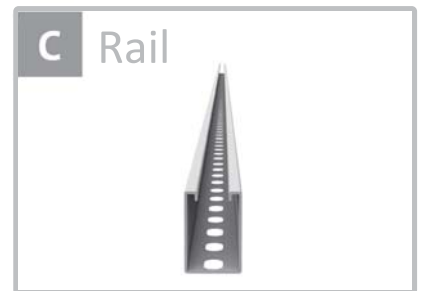
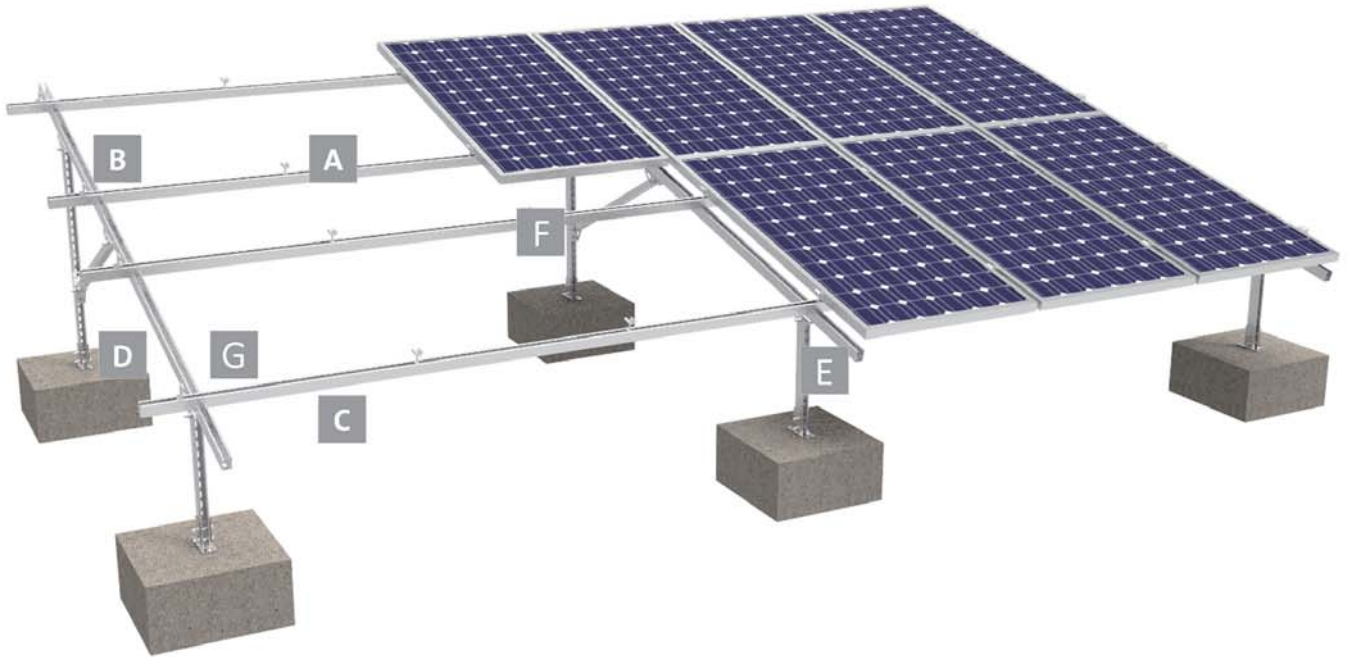

www.corigy.com

+ Installation tool



Installation Steps

① Install cement foundation

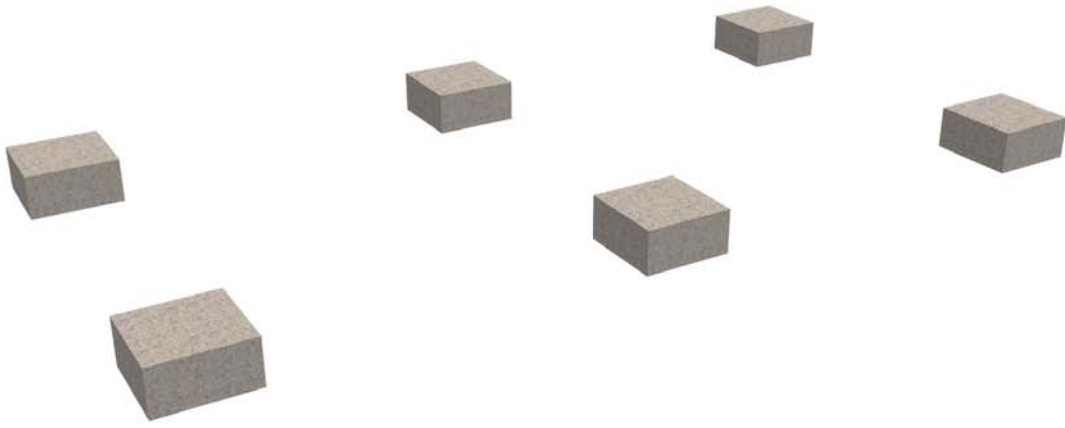

② Installation front and rear columns



■ Front and rear post installation details

A



③ Install components

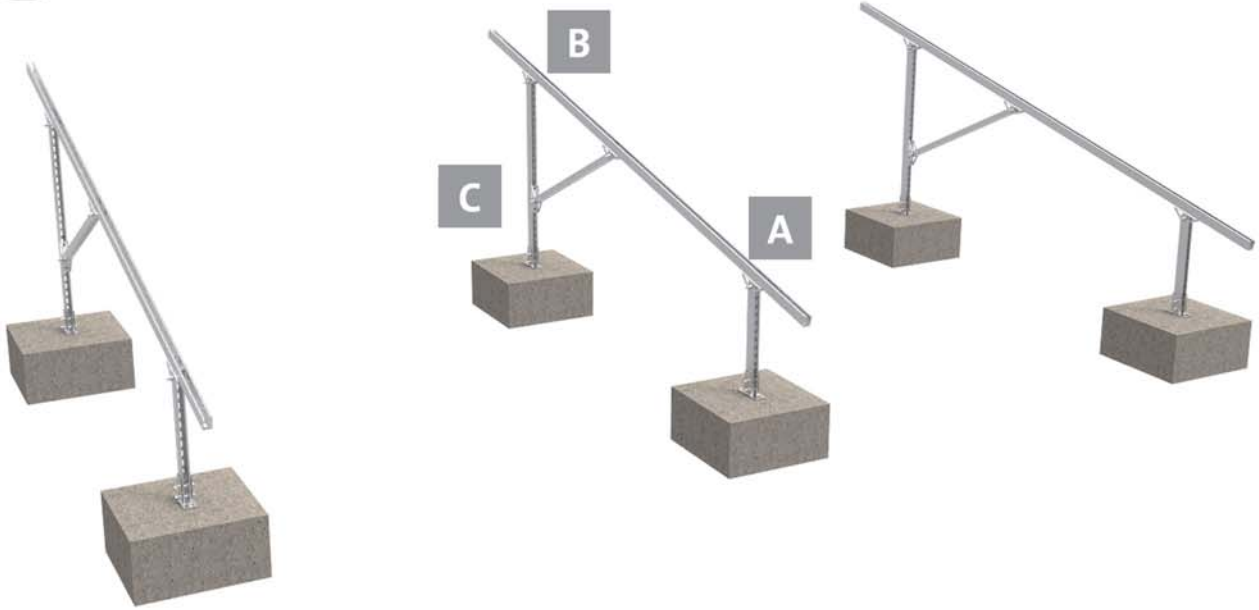

■ Component installation details

(The torque of the bolt M12 * 70 used here is 28 to 30 N.m)

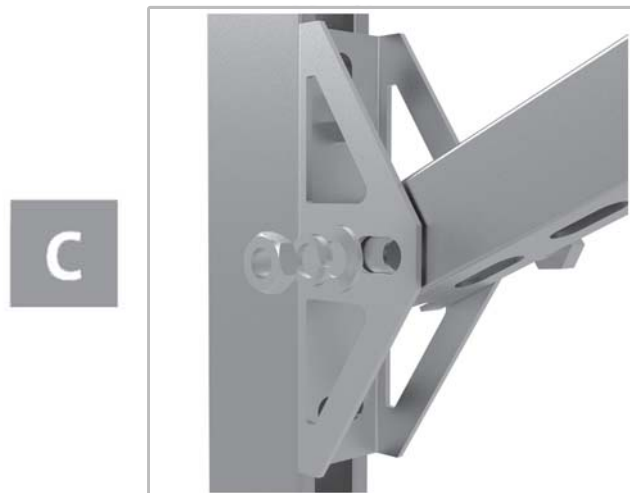

④ Mounting track

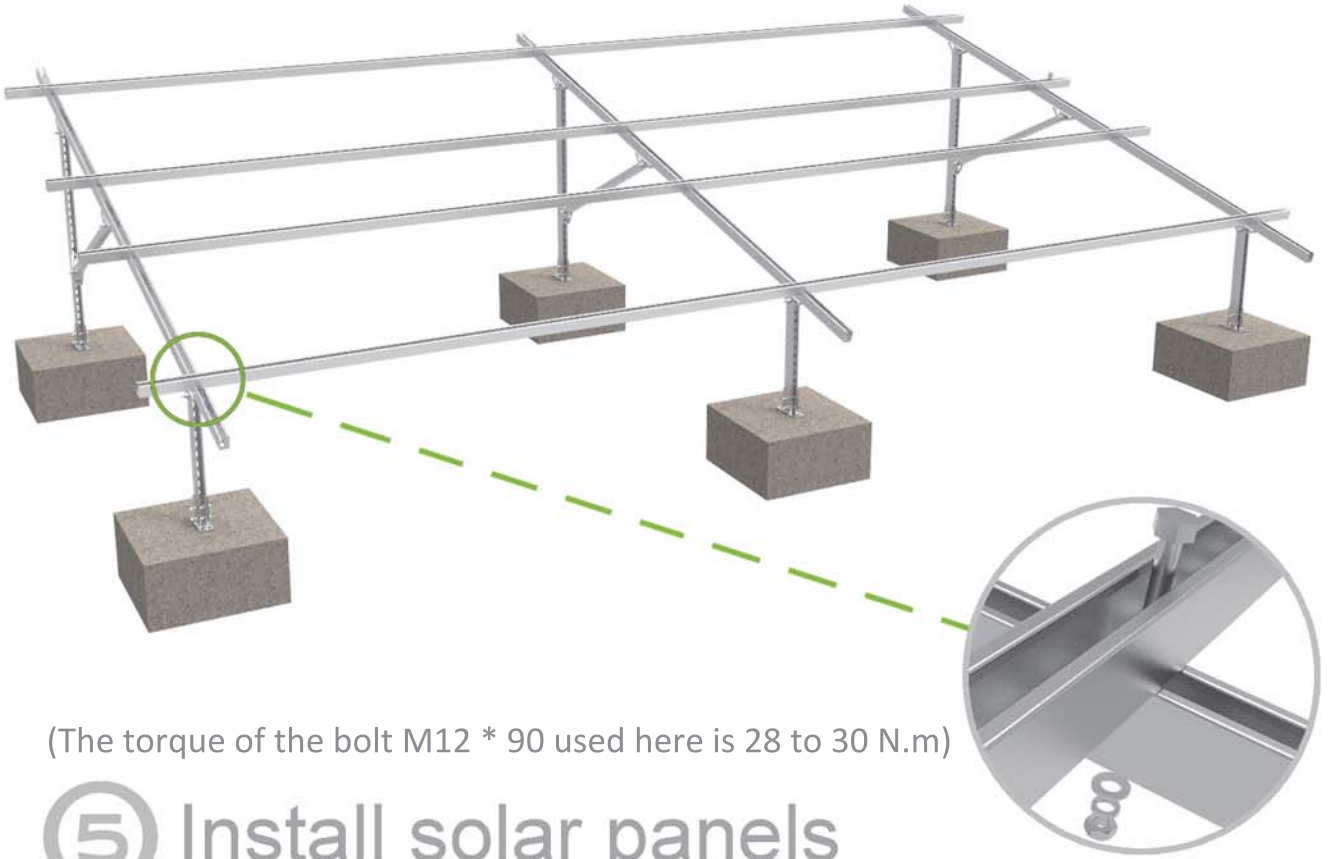

(The torque of the bolt M12 * 90 used here is 28 to 30 N.m)

⑤ Install solar panels

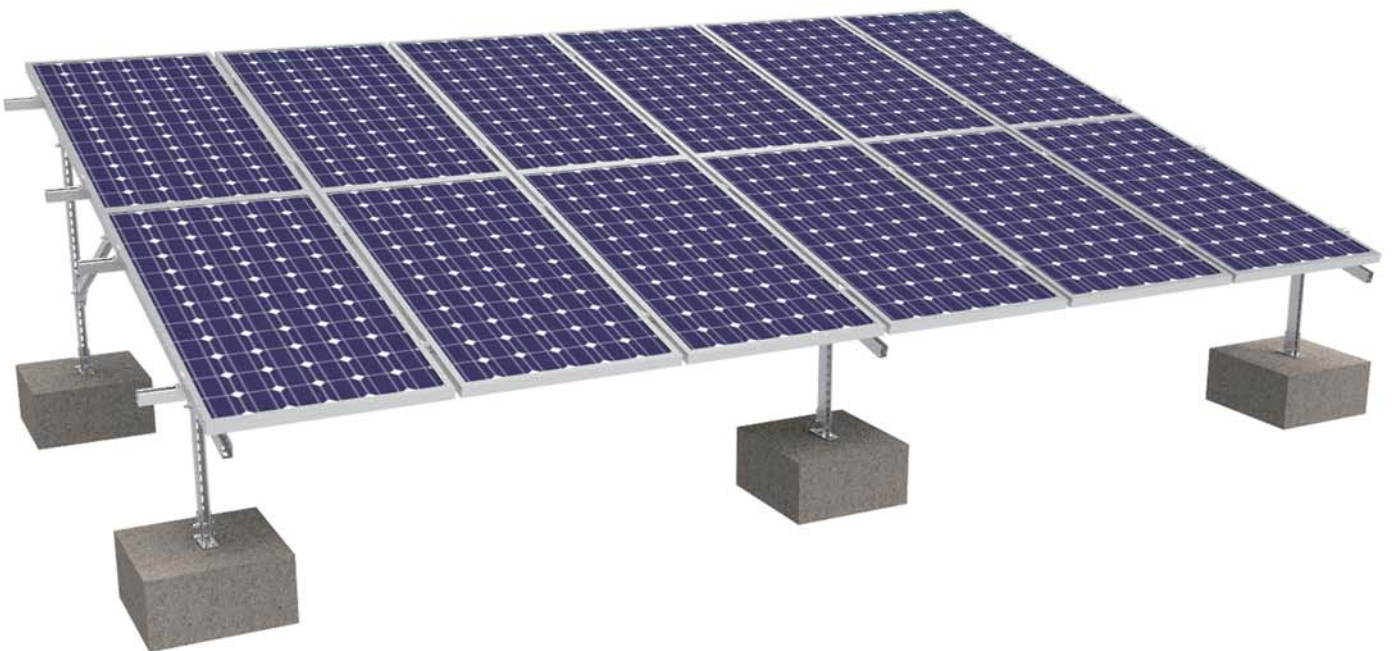

■ Solar panel installation details

A put the solar panels on and lock the end clamp

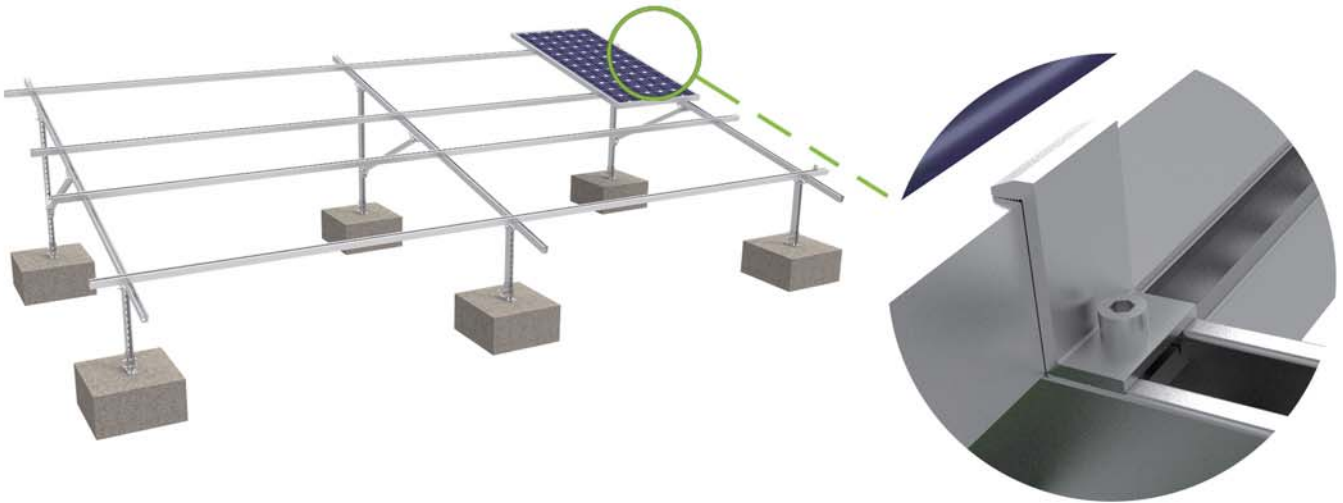

B put the solar panels on and lock the mid clamp

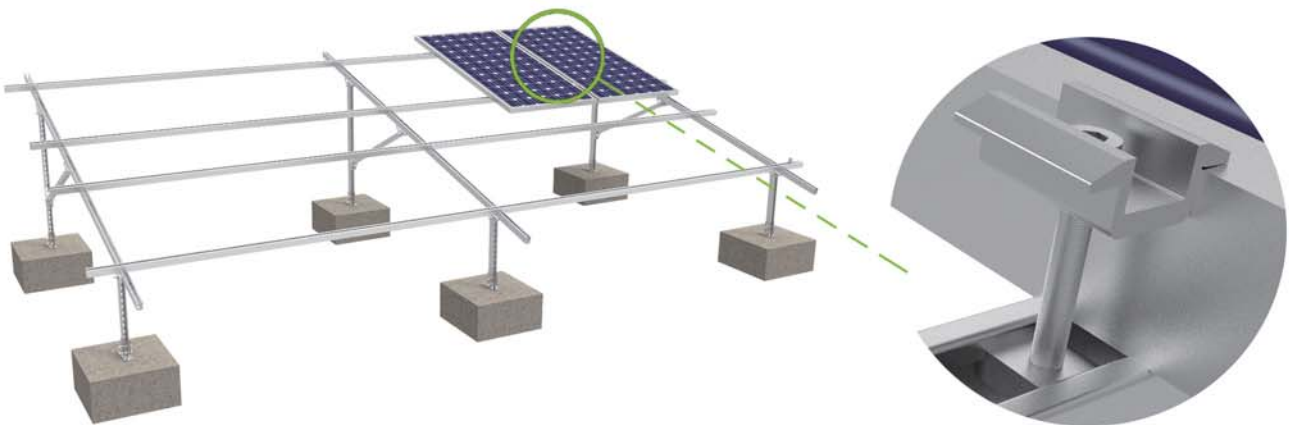

C Repeat the above action until complete

